

Evolution in Electrical Engineering for Generation, Transmission and  
Distribution

**Nikola Tesla**

Thesis submitted to the XYZ University  
for the degree of Doctor of Philosophy by Industrial Doctorate

August 1900

## Abstract

Electric power transmission is the bulk movement of electrical energy from a generating site, such as a power plant, to an electrical substation. The interconnected lines which facilitate this movement are known as a transmission network. This is distinct from the local wiring between high-voltage substations and customers, which is typically referred to as electric power distribution. The combined transmission and distribution network is part of electricity delivery, known as the "power grid" in North America.

## Acknowledgement

Firstly, I would like to express my sincere gratitude to all my researchers.

## Table of Contents

Title Page.....	1
Abstract.....	2
Acknowledgement.....	3
Table of Contents.....	4
Patent Document 1.....	
Patent Document 2.....	
Patent Document 3.....	
Patent Document 4.....	
Patent Document 5.....	

Action Continued.

10/5/86

Dated  
Model Called for

Department of Agriculture  
 PATENT BRANCH,  
 Railway A. G. [Signature]  
 April 27 1886  
 St. Joseph  
 Mr. C. F. Anselmo  
 Ottawa  
 APPLICATION FOR PATENT.  
 Dynamis Electric  
 Machines (W)  
 [Signature] Model  
 Action - [Signature] - [Signature]

PATENT No. 244033

TO ALL WHOM IT MAY CONCERN:-

Be it known that I, Nikola Tesla, <sup>formerly</sup> of Smiljan Lika, *now residing at Rahway on the State of New Jersey, United States of America, Electrician,* Border country of Austro Hungary, have invented an Improvement in Dynamo Electric Machines of which the following is a specification:-

The object of my invention is to provide an improved method for regulating the current on dynamo electric machines.

In my improvement I make use of two main brushes to which the ends of the helices of the field magnets are connected and an auxiliary brush and a branch or shunt connection from an intermediate point of the field wire to the auxiliary brush. The relative positions of the respective brushes are varied either automatically or by hand, so that the shunt becomes in-operative when the auxiliary brush has a certain position upon the commutator; but when said auxiliary brush is moved in its relation to the main brushes or the latter are moved in their relation to the auxiliary brush, the electric condition is disturbed and more or less of the current through the field helices is diverted through the shunt, or a current passed over said shunt to the field helices. By varying the relative position upon the commutator of the respective brushes automatically in proportion to the varying electrical condition of the working circuit the current developed can be regulated in proportion to the demands in the working circuit.

Devices for automatically moving the brushes in

dynamo electric machines are well known, and those made use of in my machine may be of any desired or known character.

In the drawing:

Fig. 1 is a diagram illustrating my invention showing one core of the field magnets with one helix wound in the same direction throughout.

Figs. 2 and 3 are diagrams showing one core of the field magnets with a portion of the helices wound in opposite directions.

Figs. 4 and 5 are diagrams illustrating the electric devices that may be employed for automatically adjusting the brushes and

Fig. 6 is a diagram illustrating the positions of the brushes when the machine is being energised on the start.

Figs. 7, 8, 9, 10 and 11 are diagrams that further illustrate my invention as hereafter described.

a. and b. are positive and negative brushes of the main or working circuit, and c the auxiliary brush. The working circuit D, extends from the brushes a, and b, as usual and contains electric lamps or other devices D-1 either in series or in multiple arc. M, M-1 represent the field helices, the ends of which are connected to the main brushes a, and b. The branch or shunt wire c-1 extends from the auxiliary brush c, to the circuit of the field helices and is connected to the same at an intermediate point X. H represents the commutator with the plates of ordinary construction.

It is now to be understood that when the auxiliary brush c occupies such a position upon the commutator that the electro-motive force between the brushes c and b as the resistance of the circuit a, M, c-1, c, A, to the resistance of the circuit b, M-1, c-1, c, B, the potentials of the points X and Y will be equal and no current will flow over the auxiliary brush, but when the brush c occupies a different position, the potentials of the points X and Y will be different and a current will flow over the auxiliary brush to or from the commutator, according to the relative position of the brushes. If for instance the commutator space between the brushes a and c, when the latter is at the neutral point, is diminished, a current will flow from the point Y over the shunt c to the brush b thus strengthening the current in the part M-1, and partly neutralizing the current in the part M; but if the space between the brushes a and c is increased, the current will flow over the auxiliary brush in an opposite direction and the current in M will be strengthened and in M-1 partly neutralized. By combining with the brushes a, b, and c any known automatic regulating mechanism, the current developed can be regulated in proportion to the demands in the working circuit.

The parts M and M-1 of the field wire may be wound in the same direction, (in this case they are arranged as shown in Fig. 1 or the part M may be wound in the opposite direction as shown in Figs. 2 and 3.)



It will be apparent that the respective cores of the field magnets are subjected to the neutralizing or intensifying effects of the current in the shunt through c-1 and the magnetism of the cores will be partially neutralized or the point of greatest magnetism shifted, so that it will be more or less remote from or approaching to, the armature, and hence the aggregate energizing actions of the field magnets on the armature will be correspondingly varied. In the form indicated in Fig. 1 the regulation is effected by shifting the point of greatest magnetism, and in Figs. 2 and 3 the same effect is produced by the action of the current in the shunt passing through the neutralizing helix.

In Figs. 4 and 5, A-1, A-1, indicate the main brush holder carrying the main brushes, and C, the auxiliary brush holder carrying the auxiliary brush. These brush holders are movable in arcs concentric with the center of the commutator shaft.

An iron piston P of the solenoid S, (Fig. 4) is attached to the auxiliary brush holder C. The adjustment is effected by means of a spring and screw or tightener.

In Fig. 5 instead of a solenoid an iron tube enclosing a coil is shown. The piston P of the coil is attached to both brush holders A-1, A-1 and C. When the brushes are moved directly by electrical devices as shown in Figs. 4 and 5, these are so constructed that the force exerted for adjusting is practically uniform through the whole length of motion.

The relative positions of the respective brushes may be varied by moving the auxiliary brush or the brush c may remain quiescent and the core p be connected to the main brush holder A-1 so as to adjust the brushes a, b, in their relation to the brush c. If however an adjustment is applied to all the brushes as seen in Fig. 5 the solenoid should be connected to both A-1 and C so as to move them towards or away from each other. There are several known devices for giving motion in proportion to an electric current. I have shown the moving cores in Figs. 4 and 5, as convenient devices for obtaining the required extent of motion with very slight changes in the current passing through the helices.

It is understood that the adjustment of the main brushes causes variations in the strength of the current independently of the relative position of said brushes to the auxiliary brush. In all cases the adjustment may be such that no current flows over the auxiliary brush when the dynamo is running with its normal load.

I am aware that auxiliary brushes have been used in connection with the helices of the field wire, but in these instances the helices received the entire current through the auxiliary brush or brushes and said brushes could not be taken off without breaking the current through the field. These brushes caused however a great sparking upon the commutator. In my improvement the auxiliary brush causes very little or no sparking and can be taken off

without breaking the current through the field helices. My improvement has besides the advantage to facilitate the self exciting of the machine in all cases where the resistance of the field wire is very great comparatively to the resistance of the main circuit: at the start, for instance on arc-light machines. In this case I place the auxiliary brush c, near to or in preference in contact with the brush b, as shown in Fig. 6. In this manner the part M-1, Figs. 1, 2 and 3 is completely cut out, and as the part M has a considerably smaller resistance than the whole length of the <sup>field</sup> wire the machine excites itself, whereupon the auxiliary brush is shifted automatically to its normal position.

In Figs. 7, 8, 9, 10 and 11 which further illustrate my invention, a and b are the positive and negative brushes of the main circuit, and c an auxiliary brush. The main circuit D extends from the brushes a and b, as usual and contains the helices M of the field wire, and the electric lamps or other working devices D-1. The auxiliary brush c is connected to the point x of the main circuit by means of the wire c-1. H is a commutator of ordinary construction. When the electro-motive force between the brushes a and c, is to the electro-motive force between the brushes a and b, as the resistance of the circuit a, M, c-1, c, A, to the resistance of the circuit b, B, c, c-1, D, the potentials of the points x and y, will be equal and no current will pass over the auxiliary brush c, but if said

brush occupies a different position relatively to the main brushes, the electric condition is disturbed and current will flow either from y to x, or from x to y, according to the relative position of the brushes. In the first case the current through the field helices will be partly neutralized and the magnetism of the field magnets diminished, in the second case the current will be increased and the magnets will gain strength. By combining with the brushes a, b, c, any automatic regulating mechanism the current developed can be regulated automatically in proportion to the demands in the working circuit. In practice it is sufficient to move only the auxiliary brush as shown in Fig. 4 as the regulator is very sensitive to the slightest changes, but the relative position of the auxiliary brush to the main brushes may be varied by moving the main brushes or both main and auxiliary brushes may be moved as illustrated in Fig. 5. In the latter two cases it will be understood the motion of the main brushes relatively to the neutral line of the machine, causes variations in the strength of the current independently of their relative position to the auxiliary brush. In all cases the adjustment may be such that when the machine is running with the ordinary load, no current flows over the auxiliary brush.

The field helices may be connected as shown in Fig. 7 or a part of the field helices may be in the outgoing, and the other part in the return circuit and two auxiliary

brushes may be employed as shown in Figs. 9 and 10. Instead of shunting the whole of the field helices a portion only of such helices may be shunted as shown in Fig. 8 and 10.

The arrangement shown in Fig. 10 is advantageous as it diminishes the sparking upon the commutator, the main circuits being closed through the auxiliary brushes at the moment of the break of the circuit at the main brushes.

The field helices may be wound in the same direction or a part may be wound in opposite directions.

The connection between the helices and the auxiliary brush or brushes may be made by a wire of small resistance, or a resistance may be interposed (R. Fig. 11) between the point x and the auxiliary brush or brushes to divide the sensitiveness when the brushes are adjusted.

**I CLAIM AS MY INVENTION:-**

1st. The combination with the commutator, having two or more main brushes, and an auxiliary brush, of the field helices having their ends connected to the main brushes, and a branch or shunt connection from an intermediate point of the field helices to the auxiliary brush and means for varying the relative position upon the commutator of the respective brushes, substantially as set forth.

2nd. The combination with the commutator, and main brushes and one or more auxiliary brushes, of the field helices in the main circuits and one or more shunt connections

from the field poles to the auxiliary brushes, the relative positions upon the commutator & the respective brushes being adjustable for the purpose set forth.

New York N.Y.  
Jan. 13. 1891  
Signed in the presence of  
Chas. H. Smith  
Wm. H. Dickinson

Nikola Tesla

References

- a Main brush
- b -
- c Auxiliary
- c' Shunt wire
- D Working circuit
- D' Lamp or other source
- H Commutator
- M Field coils
- X One point of connection of c'
- Y Point of contact of c with H
- Z Resistance

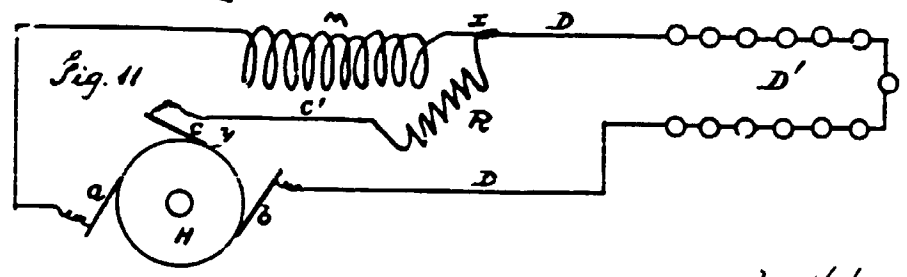
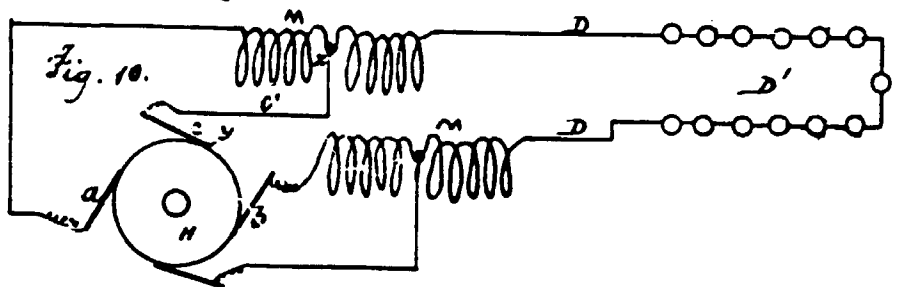
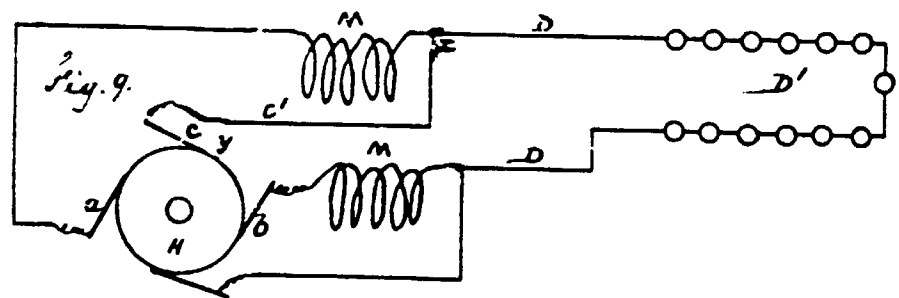
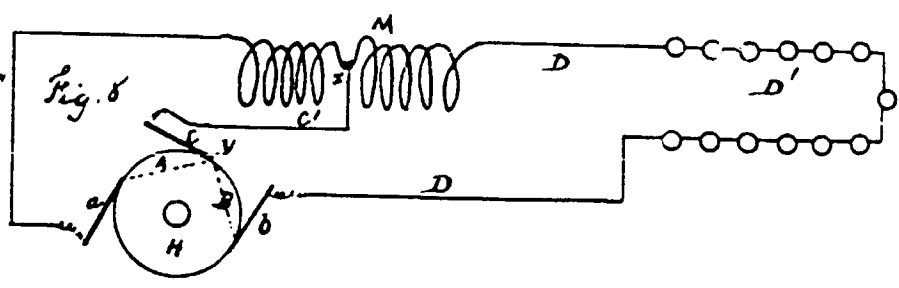
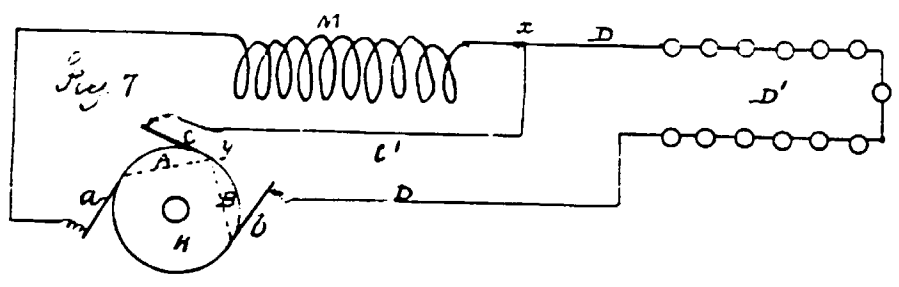

Witness

Chas. H. Smith  
 Wallace Serrell

New York 1141, Jan. 18, 1886  
 Certified to be the drawings referred to in the  
 specification herewith annexed.

Nikola Tesla  
 Inventor

for  
 Samuel W. Serrell  
 atty

Impt. in Dynamo Electric Machines

References

- A' Main Brush Holder
- a Brush, Main
- b " " " "
- C " " Auxiliary
- C' Auxiliary Brush Holder
- c' Shunt wire
- D Working Circuit
- D' Lamps or other devices
- H Commutator
- M Field Magnet
- M' " " "
- P Piston
- S Solenoid
- Z One point of connection of c'
- y Point of contact of C with H

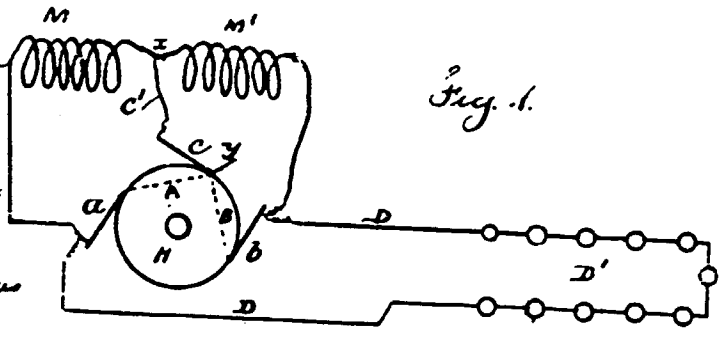

Fig. 1.

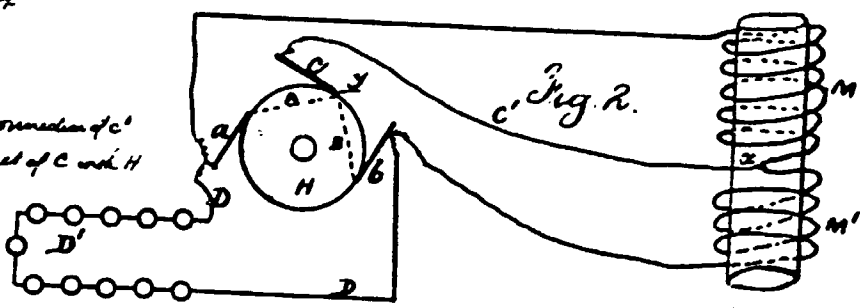

Fig. 2.

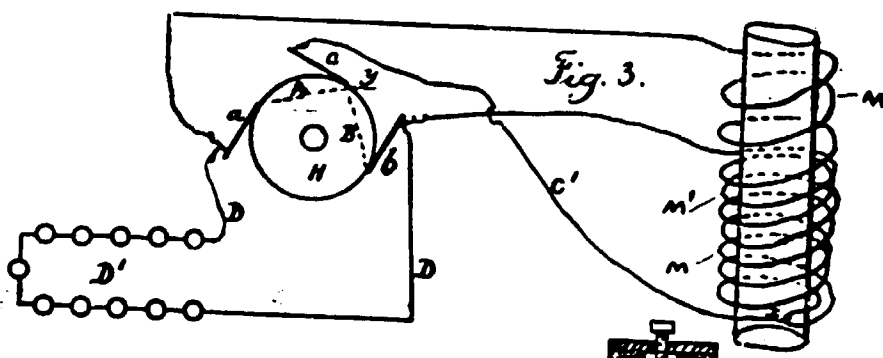

Fig. 3.

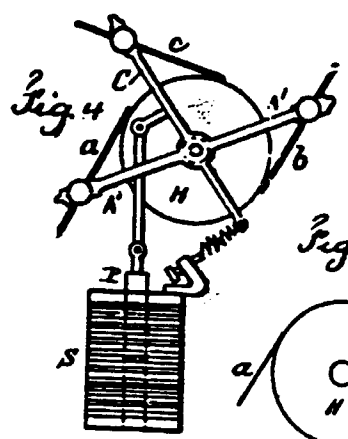

Fig. 4.

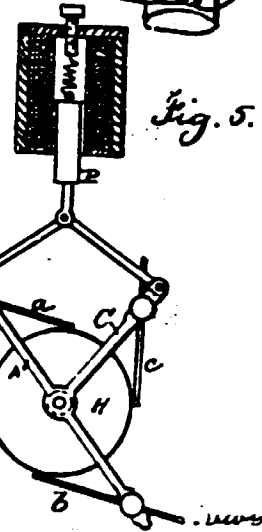

Fig. 5.

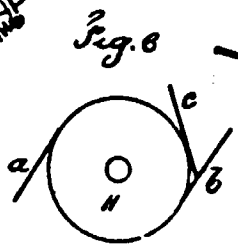

Fig. 6.

Witnesses  
 John H. Smith  
 Wallace Serrell

Witnessed at New York N.Y. June 15 1856.  
 Certified to be the drawings referred to in  
 the specification herewith annexed  
 Nikola Tesla  
 Inventor  
 for Lemuel W. Serrell

all



Papers etc. June 14/88  
re consideration June 2, 12/88  
received July 24/88

Pat. 1-8  
177/88 J. Ca

For Henry Con  
Cartons 14,772 received  
Patent dated July  
last mailed with file on  
Letter Oct. 4/4/92. Pat  
as requested Oct. 4

46937

Department of Agriculture

PATENT BRANCH

Wm. G. York

May 1 1888

J. T. Cole Assignor to  
The Galva Electric Company

For a Great  
Obtained

APPLICATION FOR PATENT

FOR  
System of Electrical  
Transmission of  
Power

\$ 2.00  
\$ 60.00  
Action of Patent May 20/88  
and receipt on filed  
Cost of this \$ 2.00  
May 14/14/88. 1888  
filed from day

172-2281  
21/1/88  
21/1/88

2. Check  
PATENT No. 29537

COST OF COPIES

PATENT & REPLICATION, \$  
REPLICATION 4.25  
DRAWING .50  
PETITION  
OATH

To all whom it may concern:-

Be it known that I, Nikola Tesla, of New York, in the County and State of New York, electrician, have invented certain new and useful Improvements in methods of an apparatus for the electrical transmission of power and I do hereby declare that the following is a full, clear and exact description of the same.

The practical solution of the problem of the electrical conversion and transmission of mechanical energy involves certain requirements which the apparatus and systems heretofore employed have not been capable of fulfilling.

Such a solution primarily demands a uniformity of speed in the motor, irrespective of its load within its normal working limits. On the other hand, it is necessary to attain a greater economy of conversion than has heretofore existed, to construct cheaper, more reliable and simple apparatus, and such that all danger and disadvantages from the use of currents of high tension, which are necessary to an economical transmission, may be avoided.

This invention comprises a new method and apparatus for effecting the transmission of power by electrical agency whereby many of the present objections are overcome and great economy and efficiency secured.

In the practice of this invention a motor is employed in which there are two or more independent energizing circuits through which are passed, in the manner hereinafter described, alternating currents, which effect a progressive shifting of the magnetism or of the "lines of

force" which, in accordance with well known theories, produces the action of the motor.

It is obvious that a proper progressive shifting or movement of the lines of force may be utilized to set up a movement or rotation of either element of the motor, the armature or the field magnet, and that if the currents directed through the several circuits of the motor are in the proper direction no commutator for the motor will be required. So, to avoid all the usual commutating appliances in the system, the motor circuits are connected directly with those of a suitable alternating current generator. The practical results of such a system, its economical advantages, and the mode of its construction and operation will be described more in detail by reference to the accompanying drawings and diagrams.

Figures 1 to 8 and 12 to 22, inclusive, are diagrams illustrating the principal of the action of this invention. The remaining Figures are views of the apparatus in various forms by means of which the invention may be carried into effect and which will be described in their order.

Referring first to Figure 9, which is a diagrammatic representation of a motor, a generator and connecting circuits in accordance with the invention, H is the motor and G the generator for driving it. The motor comprises a ring or annulus R, preferably built up of thin insulated iron rings or annular plates, so as to be as susceptible as possible to variations in its magnetic condition.

This ring is surrounded by four coils of insulated

wire, symmetrically placed, and designated by C C B' C'. The diametrically opposite coils are connected up so as to co-operate in pairs in producing free poles on diametrically opposite parts of the ring. The four free ends thus left are connected to terminals T T' T' T' as indicated.

Near the ring, and preferably inside of it, there is mounted on an axis or shaft a magnetic disk D generally circular in shape, but having two segments cut away as shown. This disk should turn freely within the ring R.

The generator G is of an ordinary type, that shown in the present instance having field magnets N S and a cylindrical armature core A wound with the two coils B B'. The free ends of each coil are carried through the shaft a' and connected respectively to insulated contact rings b b' b' b'. Any convenient form of collector or brush bears on each ring and forms a terminal by which the current to and from the ring is conveyed. These terminals are connected to the terminals of the motor by the wires L and L' in the manner indicated, whereby two complete circuits are formed, one including, say, the coils B of the generator and C' C' of the motor, and the other the remaining coils B' and C C of the generator and the motor.

It remains now to explain the mode of operation of this system, and for this purpose reference is made to the diagrams Figures 1 to 8 and 1<sup>a</sup> to 8<sup>a</sup> for an illustration of the various phases through which the coils of the generator pass when in operation, and the corresponding and resultant magnetic changes produced in the motor.

The revolution of the armature of the generator between the field magnets N S obviously produces in the coils B B' alternating currents the intensity and direction of which depend upon well known laws. In the position of the coils indicated in Figure 1, the current in the coil B is practically nil, whereas the coil B' at the same time is developing its maximum current, and by the means indicated in the description of Figure 9 the circuit including this coil may also include, say, the coils C C of the motor, Figure 1<sup>a</sup>. The result, with the proper connections, would be the magnetization of the ring R, the poles being on the line N. S.

The same order of connections being observed between the coil B and the coils C' C', the latter, when traversed by a current, tend to fix the poles at right angles to the line N S of Figure 1<sup>a</sup>. It results therefore, that when the generator coils have made one-eighth of a revolution, reaching the position shown in Figure 2, both pairs of coils C and C' will be traversed by currents which act in opposition in so far as the location of the poles is concerned. The position of the poles will therefore be determined by the resultant effects of the magnetizing forces of the coils, that is to say, it will advance along the ring to a position corresponding to one-eighth of the revolution of the armature of the generator.

In Figure 3 the armature of the generator has progressed to one-fourth of a revolution. At the point indicated the current in the coil B is maximum while in B'

it is nil, the latter coil being in its neutral position. The poles of the ring R in Figure 3<sup>a</sup> will in consequence, be shifted to a position ninety degrees from that at the start as shown. The conditions existing at each successive eighth of one revolution are in like manner shown in the remaining Figures. A short reference to these Figures will suffice to an understanding of their significance. Figures 4 and 4<sup>a</sup> illustrate the conditions which exist when the generator armature has completed three-eighths of a revolution. Here both coils are generating current, but the coil B' having now entered the opposite field is generating a current in the opposite direction, having the opposite magnetizing effect. Hence, the resultant poles will be on the line N S as shown.

In Figure 5 and 5<sup>a</sup> one half of one revolution has been completed with a corresponding movement of the polar line of the motor. In this phase coil B is in its neutral position while coil B' is generating its maximum current; the current being in the same direction as in Figure 4.

In Figure 6 the armature has completed five-eighths of a revolution. In this position coil B' develops a less powerful current, but in the same direction as before. The coil B on the other hand, having entered a field of opposite polarity, generates a current of opposite direction. The resultant poles will therefore be on the line N S Figure 6<sup>a</sup>, or in other words, the poles of the ring will be shifted along five-eighths of its periphery.

Figures 7 and 7<sup>a</sup> in the same manner illustrate

the phases of the generator and ring at three-quarters of a revolution, and Figures 8 and 8<sup>a</sup> those at seven-eighths of a revolution of the generator armature. These Figures will be readily understood from the foregoing.

When a complete revolution is accomplished, the conditions existing at the start are reestablished and the same action is repeated for the next and all subsequent revolutions, and in general, it will now be seen that every revolution of the armature of the generator produces a corresponding shifting of the poles or lines of force around the ring.

This effect is utilized to produce the rotation of a body or armature in a variety of ways. For example, applying the principle above described to the apparatus shown in Figure 9: the disk D owing to its tendency to assume that position in which it embraces the greatest possible number of magnetic lines, is set in rotation following the motion of the lines or the points of greatest attraction.

The disk D in Figure 9, is shown as cut away on opposite sides, but this will not be found essential to its operation, as a circular disk, as indicated by dotted lines, would also be maintained in rotation. This phenomenon is probably attributable to a certain inertia or resistance inherent in the metal to the rapid shifting of the lines of force through the same, which results in a continuous tangential pull upon the disk that causes its rotation. This seems to be confirmed by the fact that a circular disk of steel is more effectively rotated than

one of soft iron, for the reason that the former is assumed to possess a greater resistance to the shifting of the magnetic lines.

In illustration of other forms of apparatus by means of which this invention may be carried out, reference is now made to the remaining figures of the drawings.

Figure 10 is a view in elevation and part vertical section of a motor. Figure 12 is a top view of the same with the field in section and exhibiting a diagram of the connections. Figure 11 is an end or side view of the generator with the fields in section. This form of motor may be used in place of that described.

D is a cylindrical or drum armature core, which for obvious reasons should be split up as far as practicable to prevent the circulation within it of currents of induction. The core is wound longitudinally with two coils E E', the ends of which are respectively connected to insulated contact rings d d' d' d' carried by the shaft a upon which the armature is mounted.

The armature is arranged to revolve within an iron shell R which constitutes the field magnet or other element of the motor. This shell is preferably formed with a slot or opening r, but it may be continuous as shown by the dotted lines, and in this event it is preferably made of steel. It is also desirable that this shell should be divided up similarly to the armature and for similar reasons.

The generator for driving this motor may be such as that shown in Figure 11. This represents an annular



or ring armature A surrounded by four coils F F' F' F', of which those diametrically opposite are connected in series so that four free ends are left which are connected to the insulated contact rings b b b' b'. The ring is mounted on a shaft a' between the poles N S.

The contact rings of each pair of generator coils are connected to those of the motor respectively by means of contact brushes and the two pairs of conductors L L L'L' as indicated diametrically in Figure 12.

It is obvious from a consideration of the preceding Figures that the rotation of the generator ring produces currents in the coils F F' which, being transmitted to the motor coils, impart to the armature core of the motor, magnetic poles which are constantly shifted around the core. This effect sets up a rotation of the motor armature owing to the attractive force between the shell R and the poles of the armature, but inasmuch as the coils in this case move relatively to the shell or field magnets the movement of the coils is in the opposite direction to the progressive movement of the poles.

Other arrangements of the coils of both generator and motor are possible and a greater number of circuits may be used as will be seen in the two succeeding Figures.

Figure 13 is a diagrammatic illustration of a motor and a generator, connected and constructed in accordance with the invention. Figure 14 is an end view of the generator with its field magnets in section.

The field of the motor M is produced by six magnetic poles G' G', secured to or projecting from a ring or

frame H'. These magnets or poles are wound with insulated coils, those diametrically <sup>opposite</sup> to each other being connected in pairs so as to produce opposite poles in each pair. This leaves six free ends which are connected to the terminals t.

The armature which is mounted to rotate between the poles is a cylinder or disk D of wrought iron, on the shaft a. Two segments of the disk are cut away as shown.

The generator for this motor has, in this instance, an armature A wound with three coils K K' K" at 60 degrees apart. The ends of these coils are connected respectively to insulated contact rings e e' e" e' e" e'. These rings are connected to those of the motor in proper order by means of collecting brushes and six wires forming the independent circuits. The variations in the strength and direction of the currents transmitted through these circuits and traversing the coils of the motor produce a steadily progressive shifting of the resultant attractive force exerted by the poles G' upon the armature D and consequently keep the armature in rapid rotation. The special advantage of this disposition is in obtaining a more concentrated and powerful field. The application of this principle to systems involving multiple circuits generally will be understood from this apparatus.

Referring now to Figures 15 and 16: Figure 15 is a diagrammatic representation of a modified disposition of the invention. Figure 16 is a horizontal cross section of the motor.

In this case a disk D, of magnetic metal, preferably cut away at opposite edges as shown in dotted lines in the Figure, is mounted so as to turn freely inside two stationary coils N' N" placed at right angles to one another. The coils are preferably wound on a frame O of insulating material and their ends are connected to the fixed terminals T T' T" T'".

The generator G is a representative of that class of alternating current machines in which a stationary induced element is employed. That shown consists of a revolving permanent or electro-magnet A and four independent stationary magnets P P' wound with coils. The diametrically opposite coils being connected in series and having their ends secured to the terminals t t' t" t'". From these terminals the currents are led to the terminals of the motor, as shown in the drawing.

The mode of operation is substantially the same as in the previous cases, the currents traversing the coils of the motor having the effect to turn the disk D. This mode of carrying out the invention has the advantage of dispensing with the sliding contacts in the system.

In the forms of motor above described, only one of the elements, the armature or the field magnet is provided with energizing coils. It remains then to show how both elements may be wound with coils. Reference is therefore had to Figures 17 and 18.

Figure 17 is an end view of such a motor with a diagram of connections. Figure 18 is a view of the generator with the field magnets in section. In Figure 17 the

field magnet of the motor consists of a ring R, preferably of thin insulated iron sheets or bands with eight pole pieces G' and corresponding recesses in which four pairs of coils V are wound. The diametrically opposite pairs of coils are connected in series and the free ends connected to four terminals W. The rule to be followed in connection being the same as hereinbefore explained.

An armature D with two coils E E' at right angles to each other, is mounted to rotate inside of the field magnet R. The ends of the armature coils are connected to two pairs of contact rings d d' d' d'.

The generator for this motor may be of any suitable kind to produce currents of the desired character. In the present instance it consists of a field magnet N S and an armature A with two coils at right angles, the ends of which are connected to four contact rings b b' b' b' carried by its shaft.

The circuit connections are established between the rings on the generator shaft and those on the motor shaft by collecting brushes and wires as previously explained. In order to properly energize the field magnet of the motor, however, the connections are so made with the armature coils by wires leading thereto that while the points of greatest attraction or greatest density of magnetic lines of force upon the armature are shifted in one direction, those upon the field magnet are made to progress in an opposite direction. In other respects the operation is

identically the same as in the other cases described.

This arrangement results in an increased speed of rotation.

In Figure 17, for example, the terminals of each set of field coils are connected with the wires to the armature coils in such way that the field coils will maintain opposite poles in advance of the poles of the armature.

In the drawings the field coils are in shunts to the armature, but they may be in series or in independent circuits.

It is obvious that the same principle may be applied to the various typical forms of motor hereinbefore described.

Figure 19 is a diagram similar to figure 9, illustrating a modification in the motor. In this figure the various parts are the same as in figure 9, except that the armature core of the motor is wound with two coils at right angles to each other, the core being a cylinder or disk. The two coils form independent closed circuits. This arrangement of closed induced circuits will be found to give very efficient results.

When a motor thus constructed is not loaded, but running free the rotation of the armature is practically synchronous with the rotation of the poles in the field, and under these circumstances very little current is perceptible in the coils  $\mathcal{E}\mathcal{E}'$ , but if a load is added the speed tends to diminish and the currents in the coil are augmented so that the rotary effort is increased proportionately.

This principle of construction is obviously capable of many modified applications, most of which follow as a matter of course from the constructions described; for instance, the armature or induced coils or those in which the current are set up by induction, may be held stationary and the alternating currents from the generator conducted through the rotating inducing or field coils by means of suitable sliding contacts. It is also apparent that the induced coils may be movable and the magnetic parts of the motor stationary.

An advantage and a characteristic feature of motors constructed and operated in accordance with this plan, is their capability of almost instantaneous reversal by the reversal of one of the energizing currents from the generator.

This will be understood from a consideration of the working conditions. Assuming the armature to be rotating in a certain direction following the movement of the shifting poles, then let the direction of the shifting be reversed which may be done by reversing the connections of one of the two energizing circuits. If it be borne in mind that in a dynamo-electric machine the energy developed is very nearly proportionate to the cube of the speed, it is evident that at such moment an extraordinary power is brought to play in reversing the motor. In addition to this the resistance of the motor is very greatly reduced at the moment of reversal so that a much greater

amount of current passes through the energizing circuits.

The phenomenon alluded to, viz: The variation of the resistance of the motor, apparently like that in ordinary motors, is probably attributable to the variation in the amount of self-induction in the primary or energizing circuit.

In lieu of the field magnets for the motors shown in the drawings soft iron field magnets excited by a continuous current may be used.

This plan is a very advantageous one, but it is characteristic of a motor so operated that if the field magnet be strongly energized by its coils and the circuits through the armature coils closed, assuming the generator to be running at a certain speed, the motor will not start but if the field be but slightly energized or in general in such condition that the magnetic influence of the armature preponderates in determining its magnetic condition, the motor will start and, with sufficient current, will reach its normal or maximum speed. For this reason it is desirable to keep, at the start and until the motor has attained its normal speed, or nearly so, the field circuit open, or to permit but little current to pass through it.

Another characteristic of this form of motor is that its direction of rotation is not reversed by reversing the direction of the current through its field coils, for the direction of rotation depends, not upon the polarity of the field, but upon the direction in which the poles of the armature are shifted. To reverse the motor the connections of either of the energizing circuits must

be reversed.

It will be found if the fields of both the generator and motor be strongly energized, that starting the generator starts the motor, and that the speed of the motor is increased in synchronism with the generator.

Motors constructed and operated upon this principle maintain almost absolutely the same speed for all loads within their normal working limits, and in practice it will be observed that if the motor is suddenly overloaded to such an extent as to check its speed, the speed of the generator, if its motive power be not too great, is diminished synchronously with that of the motor. These qualities render this particular form of motor very useful under certain conditions.

With this description of the nature of the invention and of some of the various ways in which it is carried into effect, attention is called to certain characteristics which the applications of the invention possess, and the advantages which it offers.

In this motor, considering for convenience that represented in Figure 9, it will be observed that since the disk D has a tendency to follow continuously the points of greatest attraction, and since these points are shifted around the ring once for each revolution of the armature of the generator, it follows that the movement of the disk D will be synchronous with that of the armature A. This feature will be found to exist in all other forms in which one revolution of the armature of the generator produces



a shifting of the poles of the motor through three hundred and sixty degrees.

In the particular modification shown in figure 15, or in others constructed on a similar plan, the number of alternating impulses resulting from one revolution of the generator armature is double as compared with the preceding cases and the polarities in the motor are shifted around twice by one revolution of the generator armature. The speed of the motor will, therefore, be twice that of the generator.

The same result is evidently obtained by such a disposition as that shown in Figure 17 where the poles of both elements are shifted in opposite directions.

Again, considering the apparatus illustrated by figure 9, as typical of the invention, it is obvious that since the attractive effect upon the disk D is greatest when the disk is in its proper relative position to the poles developed in the ring R, that is to say, when its ends or poles immediately follow those of the ring, the speed of the motor for all loads within the normal working limits of the motor will be practically constant.

It is clearly apparent that the speed can never exceed the arbitrary limit as determined by the generator, and also that within certain limits, at least, the speed of the motor will be independent of the strength of the current.

It will now be more readily seen from the above description how far the requirements of a practical system

of electrical transmission of power are realized by this invention. It secures:-

First, a uniform speed under all loads within the normal working limits of the motor without the use of any auxiliary regulator.

Second, synchronism between the motor and generator.

Third, greater efficiency by the more direct application of the current, no commutating devices being required on either the motor or generator.

Fourth, cheapness and simplicity of mechanical construction.

Fifth, the capability of easy management and control.

Sixth, diminution of danger from injury to persons and apparatus.

These motors may be run in series, multiple arc or multiple series under conditions well understood by those skilled in the art.

The means or devices for carrying out the principle of this invention may be varied to a far greater extent than has been indicated herein, but the invention includes in general, motors containing two or more independent circuits through which the operating currents are directed in the manner described. By "independent" it is not implied that the circuits are necessarily isolated from one another, for in some instances there might be electrical connections between them to regulate or modify the action of the motor without necessarily producing a new or different action.

is not new to produce the rotation of a motor by intermittently shifting the poles of one of its elements. This has been done by passing through independent energizing coils on one of the elements, the current from a battery or other source of direct or continuous currents, reversing such currents by suitable mechanical appliances so that they are directed through the coils in alternately opposite directions. In such cases, however, the potential of the energizing currents remains the same, their direction only being changed. According to the present invention, on the other hand, true alternating currents are employed and the invention consists in the mode or method of an apparatus for utilizing such currents.

The difference between the two plans and the advantages of this one are obvious. By producing an alternating current each impulse of which involves a rise and fall of potential, the exact conditions of the generator are reproduced in the motor, and by such currents and the consequent production of resultant poles the progression of the poles will be continuous and not intermittent. In addition to this, the practical difficulty of interrupting or reversing a current of any considerable strength is such that none of the devices at present known could be made as economically or practically effect the transmission of power by reversing, in the manner described, a continuous or direct current.

In so far, then, as the plan of acting upon one element of the motor is concerned, my invention involves the use of an alternating as distinguished from a reversed current, or a current which while continuous and direct is

shifted from coil to coil by any form of commutator, reverser or interrupter. With regard to that part of the invention which consists in acting upon both elements of the motor simultaneously, the use of either alternating or reversed currents is within the scope of the invention although the use of reversed currents is not regarded as of much practical importance.

Claims:-

1. The method herein described of electrically transmitting power which consists in producing a continuously progressive movement of the polarities of either or both elements ( the armature or field magnet or magnets ) of a motor by developing alternating currents in independent circuits including the magnetizing coils of either or both elements, as herein set forth.

2. The combination with a motor containing separate or independent circuits on the armature or field or both, of an alternating current generator containing induced circuits connected independently to corresponding circuits in the motor whereby a rotation of the generator produces a progressive shifting of the poles of the motor, as herein described.

3. In a system for the electrical transmission of power, the combination of a motor provided with two or more independent magnetizing coils corresponding to the motor coils and circuits connecting directly the motor and generator coils in such order that the currents developed by the generator will be passed through the corresponding motor coils and thereby produce a progressive shifting of the poles of the motor, as herein set forth.

4. The combination with a motor having an annular or ring shaped field and a cylindrical or equivalent armature, and independent coils on the field or armature or both, of an alternating current generator having correspondingly independent coils and circuits including the generator coils and corresponding motor coils in such manner that the rotation of the generator causes a progressive shifting of the poles of the motor in the manner set forth.

5. In a system for the electrical transmission of power, the combination of the following instrumentalities, to wit: a motor composed of a disk or its equivalent mounted within a ring or annular field which is provided with magnetizing coils connected in diametrically opposite pairs or groups to independent terminals, a generator having induced coils or groups of coils equal in number to the pairs or groups of motor coils and circuits connecting the terminals of said coils to the terminals of the motor respectively and in such order that the rotation of the generator and the consequent production of alternating currents in the respective circuits produces a progressive movement of the polarities of the motor, as hereinbefore described.

6. The method herein described of operating electro magnetic motors which consists in producing a progressive shifting of the poles of its armature by an alternating current and energizing its field magnets by a continuous current as set forth.

7. The combination with a motor containing independent inducing or energizing circuits and closed induced

circuits, of an alternating current generator having induced or generating circuits corresponding to and connected with the energizing circuits of the motor, as set forth.

8. An electro-magnetic motor having its field magnets wound with independent coils and its armature with independent closed coils in combination with a source of alternating currents connected to the field coils and capable of progressively shifting the poles of the field magnet, as set forth.

New York, *April 5<sup>th</sup>* 1888

Signed in presence of

*Frank E. Hartney*  
*Frank B. Murphy.*

*Nikola Tesla*

This is the specification referred to in the affidavit of Nikola Tesla, hereto annexed, and sworn to before me this *5<sup>th</sup>* day of *April* 1888.

*Robert F. Gaylord*  
*Notary Public (12)*  
*N.Y. Co.*

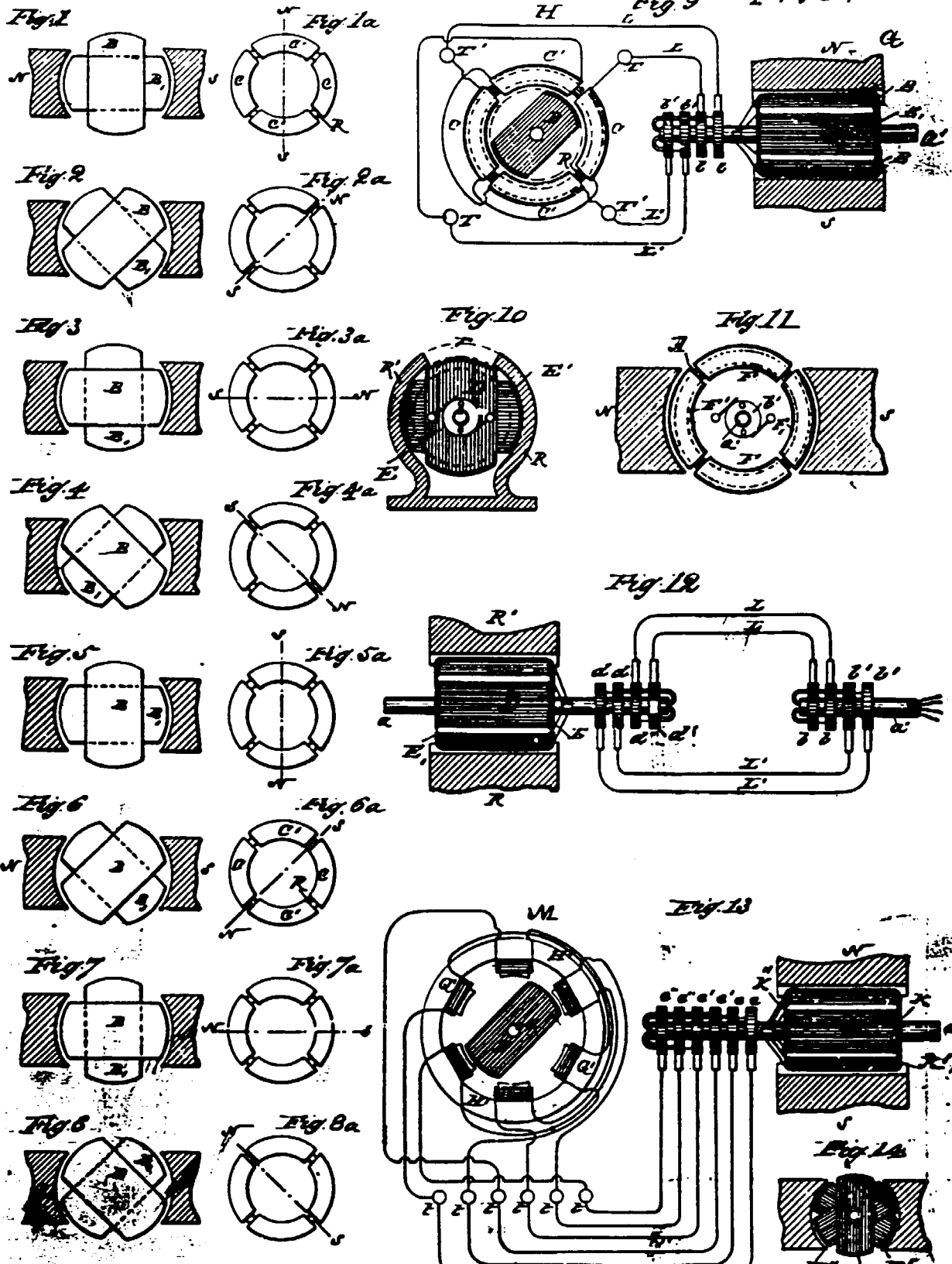

**WITNESSES:**

Richard Nelson  
Frank B. Murphy

Certified to be the drawings referred to  
in the Specification herewith annexed.  
Dated at New York  
this fifth day of April A.D. 1888

**INVENTOR:**

Nikola Tesla  
by American Centur & Co  
attys.

# System of Electrical Transmission of Power

2 9 5 3 7

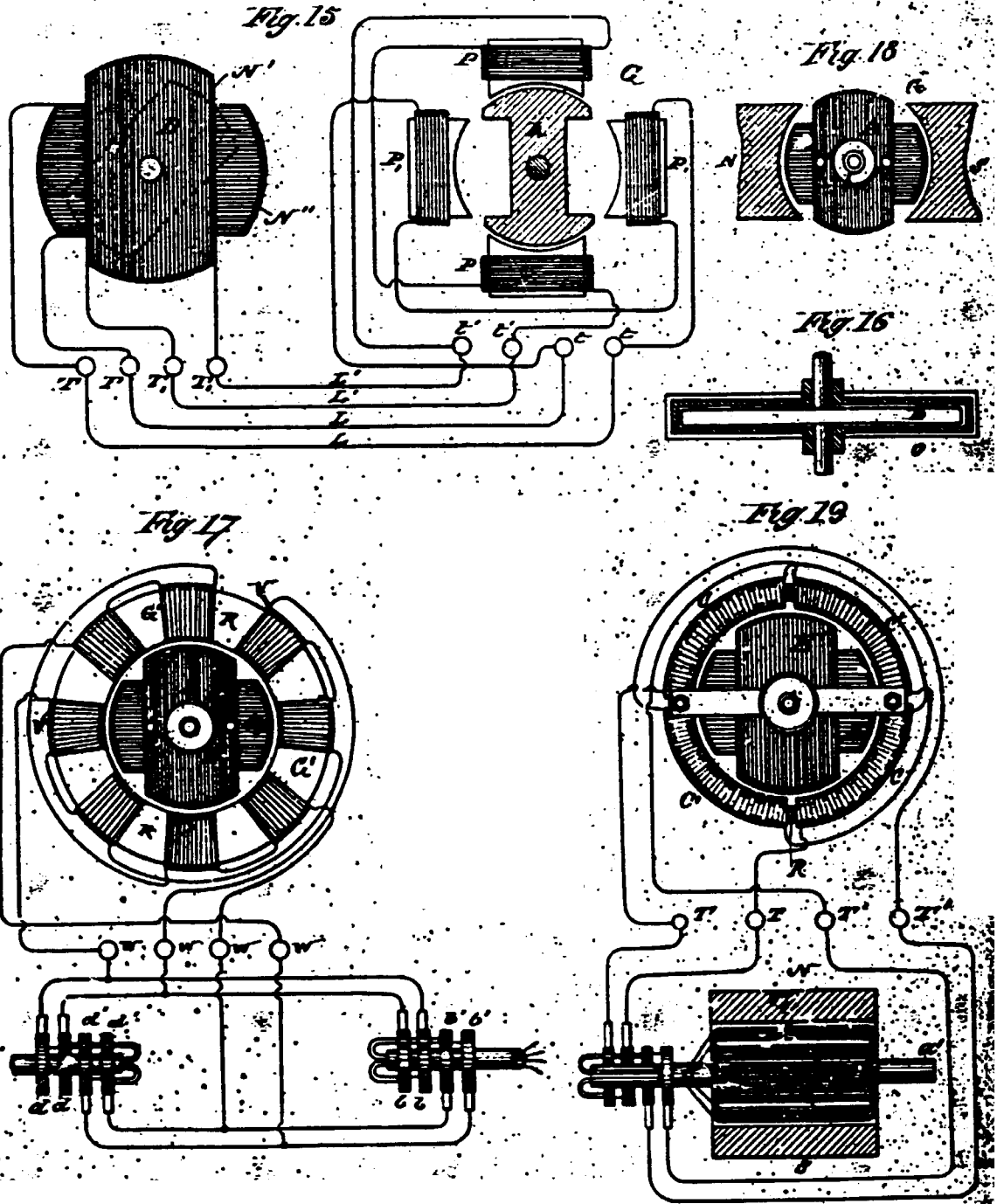

**Witnesses:**  
 Respectfully,  
 John B. Murphy, Dated at New York  
 this fifth day of April, A.D. 1888

Certified to be the drawings referred to  
 in the Specification hereto annexed  
 by Duncan Curtis Esq.

**Inventor:**  
 Nikola Tesla  
 atty.



171-97

*J.M.B.*

PATENT No. 36,172

*[Faint handwritten notes]*

*[Faint handwritten notes]*

*[Faint handwritten notes]*

COST OF COPIES.

PATENT & SPECIFICATION, 5

SPECIFICATION 2.00

DRAWING 394.25.

PETITION

OATH

367

APR 23 1888

*[Faint handwritten notes]*

*[Faint handwritten notes]*

No. 46986

Department of Agriculture.

PATENT BRANCH.

*New York*

May 1 1888

*N. Tesla - Assignor  
to Tesla Electric Co.*

*Prof. H. Priest*

*Ottawa*

APPLICATION FOR PATENT.

FOR *System of Electrical  
Conduction and  
Distribution*

*\$ 60.00*

*Model*

*CPD*

*Action etc. etc. May 2/88,*

*and receipt mailed.*

*Cost. with \$2.00 recd.*

*May 14/14/88. Receipt*

*mailed same day.*

TO ALL WHOM IT MAY CONCERN:

BE IT KNOWN, that I, NIKOLA TESLA, of New York, in the County and State of New York, electrician, have invented certain new and useful Improvements in Methods of and apparatus for converting and distributing electric currents, AND I HEREBY DECLARE, that the following is a full, clear and exact description of the same.

This invention relates to those systems of electrical distribution in which a current from a single source of supply in a main or transmitting circuit, is caused to induce, by means of suitable induction coils, a current or currents in an independent working circuit or circuits.

The main objects of the invention are the same as have been heretofore obtained by the use of these systems, viz: To divide the current from a single source whereby a number of lamps, motors or other translating devices may be independently controlled and operated by the same source of current, and in some cases to reduce a current of high potential in the main circuit to one of greater quantity and lower potential in the independent consumption circuit or circuits.

The general character of these devices is now well understood. An alternating current magneto-machine is used as the source of supply. The current developed thereby is conducted through a transmission circuit to one or more distant points at which the transformers are located. These consist of induction machines of various kinds; in some cases ordinary forms of induction coil

have been used, with one of the coils in the transmitting circuit and the other in a local or consumption circuit, the coils being differently proportioned according to the work to be done in the consumption circuit. That is to say, if the work requires a current of higher potential than that in the transmission circuit the secondary or induced coil is of greater length and resistance than the primary, while on the other hand, if a quantity current of lower potential is wanted the longer coil is made the primary.

In lieu of these devices various forms of electro-dynamic induction machines, including the combined motors and generators, have been devised. For instance, a motor is constructed in accordance with well understood principles and on the same armature are wound induced coils which constitute the generator. The motor coils are generally of fine wire and the generator coils of coarser wire so as to produce a current of greater quantity and lower potential than the line current which is of relatively high potential to avoid loss in long transmission. A similar arrangement is to wind coils corresponding to those described on a ring or similar core and by means of a commutator of suitable kind to direct the current through the inducing coils successively so as to maintain a movement of the poles of the core and of the lines of force which set up the currents in the induced coils.

Without enumerating the objections to these systems in detail, it will suffice to say that the theory or

the principle of the action or operation of these devices has apparently been so little understood that their proper construction and use has, up to the present time, been attended with various difficulties and great expense. Transformers are very liable to be injured and burnt out, and the means resorted to for curing this and other defects have invariably been at the expense of efficiency.

This invention comprises a method of and apparatus for the conversion and distribution of electrical energy which is not subject to the objections above alluded to and which is both efficient and safe. The result is obtained through a conversion by true dynamic induction under highly efficient conditions and without the use of expensive or complicated apparatus or moving devices which in use are liable to wear out or require attention.

This method consists in progressively and continuously shifting the line or points of maximum effect in an inductive field across the convolutions of a coil or conductor within the influence of said field and included in or forming part of a secondary or working circuit.

For carrying out this invention a series of inducing coils and corresponding induced coils is provided which, by preference are wound upon a core closed upon itself. Such a core, for instance, as is used in the Grammetype of dynamo-machine. The two sets of coils are wound upon this core side by side or superposed, or otherwise placed in well known ways to bring them into the most effective relations to one another and to the core.

The inducing or primary coils wound on the core are divided into pairs or sets, and they are so connected electrically that while the coils of one pair or set cooperate in fixing the magnetic poles of the core at two given diametrically opposite points, the coils of the other pair or set--assuming, for the sake of illustration, that there are but two--tend to fix the poles at ninety degrees from such points.

With ~~this~~ induction device or converter an alternating current generator is used with coils or sets of coils to correspond with those of the converter and by means of suitable conductors the corresponding coils of the generator and converter are connected up in independent circuits. It results from this that the different electrical phases in the generator are attended by corresponding magnetic changes in the converter or in other words, that as the generator coils revolve, the points of greatest magnetic intensity in the converter will be progressively shifted or whirled around. This principle of operation may be variously modified and applied to the operation of electro-magnetic motors and the various conditions under which it may be so applied will suggest modifications in the present system. The intention herein, therefore, is merely to describe the best and the most convenient manner for carrying out the invention as applied to a system of electrical distribution. It will be understood that the form of both the generator and converter may be very greatly modified.

In illustration of the details of construction which the invention involves, reference is made to the accompanying drawings. The Figure being a diagram of the converter and the generator with their proper electrical connections.

A is a core which is closed upon itself, that is to say, it is of an annular, cylindrical or equivalent form; and as the efficiency of the apparatus is largely increased by the subdivision of this core it is made of thin strips plates or wires of soft iron electrically insulated from one another as far as practicable. Upon this core by any well known method are wound, for example, four coils B B E' B' which constitute the primary coils and which are composed of long lengths of comparatively fine wire. Over these coils shorter coils of coarser wire C C C' C' are wound which constitute the induced or secondary coils. The construction of this or any equivalent form of converter may be carried further by enclosing these coils with iron, as, for example, by winding over the coils a layer or layers of insulated iron wire.

The device is provided with suitable binding posts to which the ends of the coils are connected. The diametrically opposite coils B B and E' B' are connected respectively in series and the four terminals are connected to the binding posts. The induced coils are connected together in any desired manner. For example, coils C C may be connected in multiple arc when a quantity current is desired, as for running a group of incandescent

lamps D, while C' C' may be independently connected in series in a circuit including arc lamps or the like.

The generator in this system will be adapted to the converter in the manner illustrated. For example, in the present case it consists of a pair of ordinary permanent or electro-magnets E E, between which a cylindrical armature core is mounted on a shaft F and wound with two coils G G'. The terminals of these coils are connected respectively to four insulated or collecting rings H H H' H' and the four line circuit wires L connect the brushes K bearing on these rings to the converter in the order shown.

Noting the results of this combination it will be observed that at a given point of time the coil G is in its neutral position and is generating little or no current while the other coil G' is in a position where it exerts its maximum effect. Assuming coil G to be connected in circuit with coils B B of the converter and coil G' with coils B' E' it is evident that the poles of the ring A at such point of time will be determined by the current in coils B' E' alone. But as the armature of the generator revolves, coil G develops more current and coil G' less, until G reaches its maximum and G' its neutral position.

The obvious result will be to shift the poles of the ring A through one quarter of its periphery. The movement of the coils of the generator through the next quarter of a turn, during which coil G' enters a field of opposite polarity and generates a current of opposite direction, and increasing strength, while coil G is passing

from its maximum to its neutral position and generates a current of decreasing strength and same direction as before and causes a further shifting of the poles through the second quarter of the ring. The second half revolution will obviously be a repetition of the same action.

By shifting the poles of the ring A a powerful dynamic inductive effect is exerted upon the coils C C'.

Besides the currents generated in the secondary coil by dynamo-magnetic induction, other currents will be set up in the same coils in consequence of any variation in the intensity of the poles in the ring A. This should be avoided by maintaining the intensity of the pole constant, to accomplish which, care should be taken in designing and proportioning the generator and in distributing the coils on the rings A and balancing their effect. When this is done the currents are produced by dynamo-magnetic induction only, the same result being obtained as though the poles were shifted by a commutator with an infinite number of segments.

#### Claims:

1. The method of electrical conversion and distribution herein described which consists in continuously and progressively shifting the points or lines of maximum effect in an inductive field and inducing thereby currents in the coils or convolutions of a circuit located within the inductive influence of said field, as herein set forth.

2. The method of electrical conversion and dis-



tribution herein described, which consists in generating in independent circuits producing an inductive field, alternating currents in such order or manner as to produce by their conjoint effect a progressive shifting of the points of maximum effect of the field and inducing thereby currents in the coils or convolutions of a circuit located within the inductive influence of the field, as set forth.

3. The combination with a core closed upon itself, inducing or primary coils wound thereon and connected up in independent pairs or sets and induced or secondary coils wound upon or near the primary coil, of a generator of alternating currents and independent circuits connecting the primary coils with the corresponding coils of the generator, as herein set forth.

4. The combination with independent electric transmission circuits, of transformers consisting of annular or similar cores wound with primary and secondary coils, the opposite primary coil of each transformer being connected to one of the transmission circuits, an alternating current generator with independent induced or armature coils connected with the transmission circuit whereby alternating currents may be directed through the primary coils of the transformers in the order and manner herein described.

New York, <sup>the</sup> April 5, 1888.

*Nikola Tesla*

Signed in presence of

*Frank E. Hartley*  
*Frank O. Murphy*

This is the specification referred to in the affi-

*System of Electrical Conversion  
and Distribution.*

30172

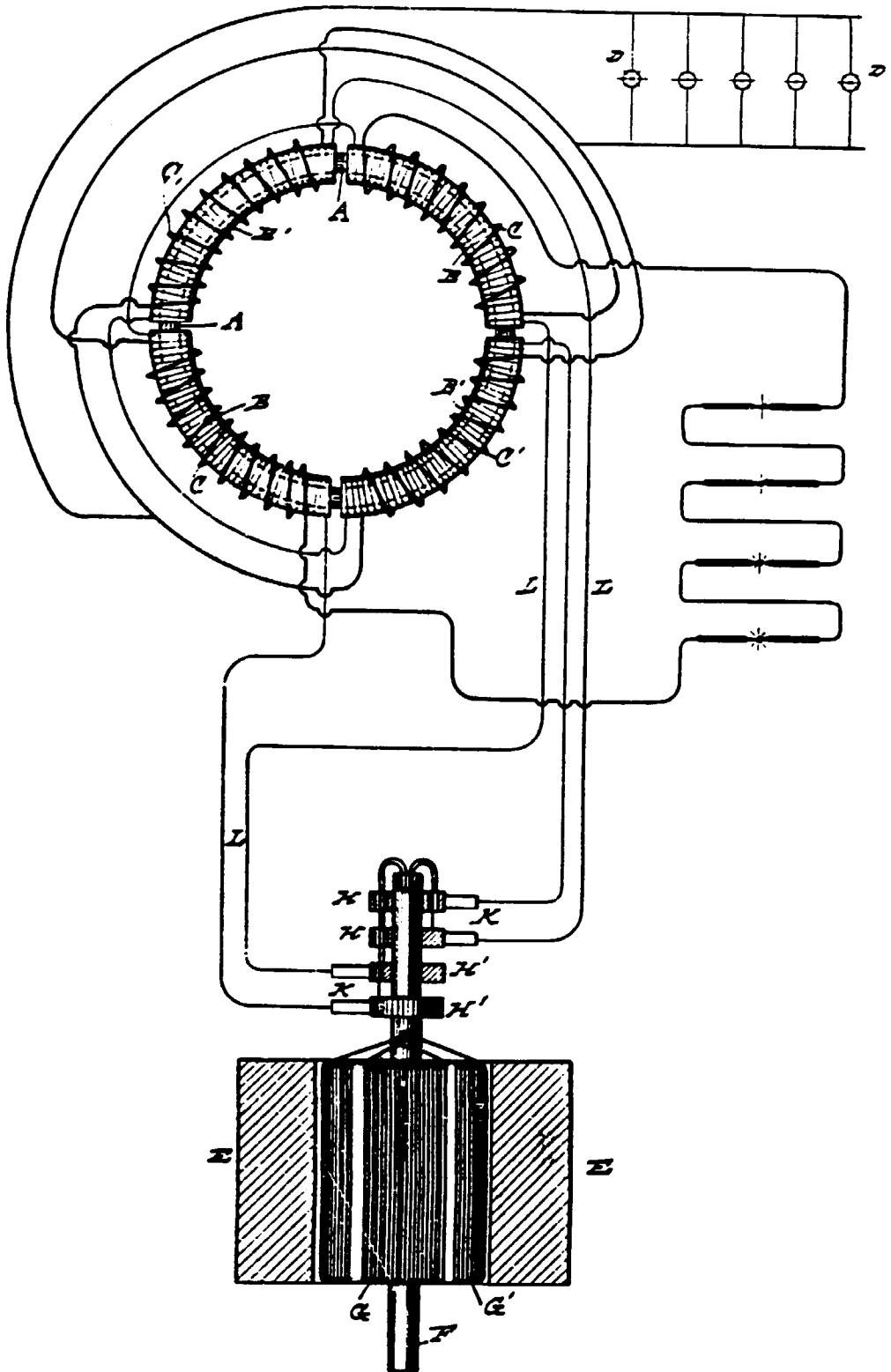

*Witnesses:* *Certified to be the drawings referred to* *Inventor:*  
*Nikola Tesla*  
*Frank O. Murphy, Dated at New York.* *Witness, Carter & Sage*  
*this fifth day of April A. D. 1888.* *attys.*

171-203  
York

PATENT No. 33519

No. 51875

Department of Agriculture

PATENT BRANCH

New York

Dec 19 1889

St. Louis

N. York

Utama

APPLICATION FOR PATENT

Granting

Utama

Dec 20 1889

COST OF COPIES

PATENT & SPECIFICATION

REPLICATION

DRAWING

PRINTING

DATE

W. H. ...

W. H. ...

Receipt made

Dec 20 1889

S P E C I F I C A T I O N .

---

TO ALL WHOM IT MAY CONCERN:-

BE IT KNOWN, THAT I, NIKOLA TESLA, from Smiljan, Lika, Border Country of Austria Hungary, resident of New York, in the County and State of New York, Electrician, have invented certain new and useful improvements in methods and apparatus for Converting Alternating into Direct Currents, and I do hereby declare that the following is a full, clear, and exact description of the same.

In nearly all the more important industrial applications of electricity, the current is produced by dynamo-electric machines driven by power, in the coils of which the currents developed are primarily in reverse directions or what is known as alternating. As many electrical devices and systems, however, require direct current, it has been usual to correct the current alternations by means of a commutator instead of taking them off directly from the generating coils.

The superiority of alternating current machines in all cases where their currents can be used to advantage, renders their employment very desirable, as they may be much more economically constructed and operated and the object of this invention is to provide means for directing or converting at will at one or more points in a circuit, alternating into direct currents.

Stated broadly, the invention consists in obtaining direct from alternating currents, or in directing the waves of an alternating current so as to produce direct or substantially direct currents, by developing or producing in the branches of the circuit including a source of alternating currents, either permanently or periodically, and by electric, electro-magnetic, or magnetic agencies, manifestations of energy or what may be termed active resistances of opposite electrical character whereby the currents or current waves of opposite sign or direction will be diverted through different circuits, those of one sign passing over one branch and those of opposite sign over another.

The case of a circuit divided into two paths only may be considered herein inasmuch as any further subdivision involves merely an extension of the same general principle.

Selecting then, any circuit through which is flowing an alternating current, let such circuit be divided at any desired point into two branches or paths. In one of these paths is inserted some device to create an electro-motive force opposed to the waves or impulses of current of one sign, and a similar device in the other branch which opposes the waves of opposite signs.

that  
Assume, for example, these devices are batteries,  
primary or secondary, or continuous current dynamo ma-  
chines. The waves or impulses of opposite direction,  
composing the main current, have a natural tendency to  
divide between the two branches, but by reason of the oppo-  
site electrical character or effect of the two branches,  
one will offer an easy passage to a current of a certain  
direction, while the other will offer a relatively high  
resistance to the passage of the same current.. The  
result of this distribution is that the waves of current  
of one sign will - partly or wholly - pass over one of  
the paths or branches while those of the opposite sign  
pass over the other.

There may be thus obtained from an alternating cur-  
rent two or more direct currents, without the employment  
of any commutator such as it has been heretofore regard-  
ed as necessary to use. The current in either branch  
may be used in the same way and for the same purposes as  
any other direct current, that is, it may be made to  
charge secondary batteries, energize electro-magnets, or  
used for any other analagous purpose.

In the drawings some of the various ways in which  
this invention may be carried out are illustrated.

The several figures are diagrammatic in character  
and will be described in detail in their order.

Figure 1 represents a plan of directing the alter-

nating currents by means of devices purely electrical in character. A designates a generator of alternating currents and B, B, the main or line circuit therefrom.

At any given point in this circuit at or near which it is desired to obtain direct currents, the circuit B is divided into two paths or branches C, D. In each of these branches is placed an electrical generator which for the present may be assumed to produce direct or continuous currents.

The direction of the current thus produced is opposite in one branch to that of the current in the other branch, or considering the two branches, as forming a closed circuit, the generators E, F, are connected up in series therein, one generator in each part or half of the circuit.

The electromotive force of the current sources E and F may be equal to, or higher or lower than the electromotive forces in the branches C, D, or between the points X and Y of the circuit B, B. If equal, it is evident that current waves of one sign will be opposed in one branch and assisted in the other to such an extent that all of the waves of one sign will pass over one branch and those of opposite sign over the other. If, on the other hand, the electromotive force of the sources E, F, be lower than that between X and Y, the currents in both branches will be alternating, but the waves of one sign will preponderate.

One of the generators or sources of current E, or P, may be dispensed with, but it is preferable to employ both, if they offer an appreciable resistance, as the two branches will be thereby better balanced. The translating or other devices to be acted upon by the current are designated by the letters G, and they are inserted in the branches C, D, in any desired manner, but in order to better preserve an even balance between the branches due regard should be had to the number and character of the devices as will be well understood.

Figures 2, 3, 4, and 5, illustrate what may be termed electro-magnetic devices for accomplishing a similar result. That is to say, instead of producing directly by a generator an electro-motive force in each branch of the circuit, a field or fields of force is established, and the branches led through the same in such manner that an active opposition of opposite effect or direction will be developed therein by the passage or tendency to pass off the alternations of current.

In figure 2, for example, A is the generator of alternating currents, B, B, the line circuit, and C D-the branches over which the alternating currents are directed. In each branch is included the secondary of a transformer or induction coil, which, since they correspond in their functions to the batteries of the previous



figure, are designated by the letters E, F.

The primaries H, H' of the induction coils or transformers are connected either in parallel or series with a source of direct or continuous current J, and the number of convolutions is so calculated for the strength of the current from I, that the coils J, J' will be saturated.

The connections are such that the conditions in the two transformers are of opposite character, that is to say, the arrangement is such that a current wave or impulse corresponding in direction with that of the direct current in one primary as H, is of opposite direction to that in the other primary, H', hence it results that while one secondary offers a resistance or opposition to the passage through it of a wave of one sign, the other secondary similarly opposes a wave of opposite sign. In consequence, the waves of one sign will, to a greater or less extent, pass by the way of one branch, while those of opposite sign in like manner pass over the other branch.

In lieu of saturating the primaries by a source of continuous current, they may be included in the branches C, D, respectively, and their secondaries periodically short-circuited by any suitable mechanical devices, such as an ordinary revolving commutator.

It will be understood of course, that the rotation and action of the commutator must be in synchronism or in proper accord with the periods of the alternation in order to secure the desired results.

Such a disposition is represented diagrammatically in Figure 3. Corresponding to the previous figures, A is the generator of alternating currents, B, B', the line and C, D, the two branches for the direct currents. In branch C are included two primary coils E, E', and in branch D are two similar primaries F, F'. The corresponding secondaries for these coils and which are on the same subdivided cores J and J', are in circuits, the terminals of which connect to opposite segments K, K' and L, L', respectively of a commutator, Brushes b b bear upon the commutator and alternately short-circuit the plates K and K' and L and L' through a connection c. It is obvious that either the magnets and the commutator or the brushes may revolve.

The operation will be understood from a consideration of the effects of closing or short-circuiting the secondaries. For example, if at the instant when a given wave of current passes, one set of secondaries be short-circuited nearly all the current flows through the corresponding primaries, but the secondaries of the other branch being open circuited, the self-induction in the primaries is highest and hence little or no current will pass through that branch.

If as the current alternates, the secondaries of the two branches are alternately short-circuited, the result will be that the currents of one sign pass over one branch and those of the opposite sign over the other.

The disadvantages of this arrangement which would seem to result from the employment of sliding contacts, is in reality very slight, inasmuch as the electromotive force of the secondaries may be made exceedingly low so that sparking at the brushes is avoided.

Figure 4 is a diagram partly in section of another plan of carrying out the invention.

The circuit B in this case is divided as before and each branch includes the coils of both the field and revolving armatures of two induction devices. The armatures O, P, are preferably mounted on the same shaft, and are adjusted relatively to one another in such manner that when the self-induction in one branch as C is maximum, in the other branch D it is minimum.

The armatures are rotated in synchronism with the alternations from the source A. The winding or position of the armature coils is such that a current in a given direction passed through both armatures would establish in one, poles similar to those in the adjacent poles of the field, and in the other, poles unlike the adjacent field poles, as indicated by n, n, s, s, in the drawing.

If the like poles are presented as shown in cir-

cuit D, the condition is that of a closed secondary upon a primary, or in the position of least inductive resistance, hence a given alternation of current will pass mainly through D.

A half revolution of the armatures produces an opposite effect and the succeeding current impulse passes through C.

Using this figure as an illustration it is evident that the fields N, M, may be permanent magnets or independently excited and the armatures O, P, driven as in the present case so as to produce alternate currents which will set up alternately, impulses of opposite direction in the two branches D, C, which in such case would include the armature circuits and translating devices only.

In Figure 5 a plan alternative with that shown in Figure 3 is illustrated. In the previous case illustrated, each branch C and D contained one or more primary coils, the secondaries of which were periodically short-circuited, in synchronism with the alternations of current from the main source A, and for this purpose a commutator was employed. The matter may, however, be dispensed with, and an armature with a closed coil substituted.

Referring to Figure 5, in one of the branches, as C, are two coils M' wound on laminated cores and in the other branches D are similar coils M'. A subdivided or laminated armature O' carrying a closed coil R' is

rotably supported between the coils M' N' as shown.

In the position shown, that is with the coil R' parallel with the convolutions of the primaries N' M', practically the whole current will pass through branch D, because the self-induction in coils M' M' is maximum.

If, therefore, the armature and coil be rotated in synchronism with the alternations of the source A, the same results are obtained as in the case of Figure 3.

Figure 8 is an instance of what may be called in distinction to the others, a magnetic means of securing the results arrived at in this invention. V and W are two strong permanent magnets, provided with armatures V' W' respectively. The armatures are made of thin laminas of soft iron or steel, and the amount of magnetic metal which they contain is so calculated that they will be fully or nearly saturated by the magnets. Around the armatures are coils E F, contained respectively in the circuits C and D.

The connections and electrical conditions in this case are similar to those in Figure 2, except that the current source I of Figure 2 is dispensed with and the saturation of the core of coils E F obtained from the permanent magnets.

In the illustrations heretofore given, the two branches or paths containing the translating or induction devices and in each instance shown as in derivation one to the other, but this is not always necessary.

For example, in Figure 7, is an alternating current generator, B, B, the line wires or circuit. At any given point in the circuit two paths as D D', are formed, and at another point two paths as C C'. Either pair of group of paths is similar to the previous dispositions with the electrical source or induction device in one branch only, while the two groups taken together form the obvious equivalent of the cases in which an induction device or generator is included in both branches.

In one of the paths as D are included the devices to be operated by the current. In the other branch as D' is an induction device that opposes the current impulses of one direction and directs them through the branch D. So also in branch C are translating devices G and in the branch C' an induction device or its equivalent that diverts through C, impulses of opposite direction to those diverted by the device in branch D'.

A special form of induction device for this purpose is also shown. J J' are the cores formed with pole pieces upon which are wound the coils M N. Between these pole pieces are mounted at right angles to one another the magnetic armatures O P, preferably mounted on the same shaft and designed to be rotated in synchronism with the alternations of current. When one of the armatures is in-line with the poles or in the position occupied by armature P, the magnetic circuit of the induction

device is practically closed, hence there will be the greatest opposition to the passage of a current through coils N N. The alternation will therefore pass by way of branch D; at the same time, the magnetic circuit of the other induction device being broken by the position of the armature O, there will be less opposition to the current in coils M which will shunt the current from branch C.

A reversal of the current being attended by a shifting of the armatures the opposite effect is produced.

There are many other modifications of the means or methods of carrying out this invention, but it is not deemed necessary herein to specifically refer to more than those described as they involve the chief modifications of the plan. In all of these it will be observed that there is developed in one or all of the branches of a circuit from a source of alternating currents an active (as distinguished from a dead) resistance, or opposition to the currents of one sign for the purpose of diverting the currents of that sign through the other or another path, but permitting the currents of opposite sign to pass without substantial opposition.

Whether the division of the currents or waves of current of opposite sign be effected with absolute precision or not is immaterial to the invention since it will be sufficient if the waves are only partially diverted or directed, for in such case the preponderating

influence in each branch of the circuit of the waves of one sign secures the same practical results in many if not all respects as though the current were direct and continuous.

An alternating and direct current have been combined so that the waves of one direction or sign were partially or wholly overcome by the direct current, but by this plan only one set of alternations are utilized, whereas by this system the entire current is rendered available.

By obvious applications of this discovery, it is possible to produce a self-exciting alternating dynamo, or to operate direct current meters on alternating current circuit, or to run various devices, such as arc lamps, by direct currents in the same circuit with incandescent lamps or other devices run by alternating currents.

#### C L A I M S.

1. The method herein set forth of obtaining direct from alternating currents, which consists in developing or producing in one branch of a circuit from an alternating current source an active resistance to the current impulses of one direction, whereby the said currents or waves of current will be diverted or directed through another branch.

2. The method of obtaining direct from alterna-



ting currents, which consists in dividing the path of an alternating current into branches and developing in one of said branches, either permanently or periodically, an electrical force or active resistance counter to or opposing the currents or current waves of one sign, and in the other branch a force counter to or opposing the currents or current waves of opposite sign, as set forth.

3. The method of obtaining direct from alternating currents, which consists in dividing the path of the alternating current into branches, establishing fields of force and leading the said branches through said fields of force in substantially the manner set forth, whereby electro-motive forces of opposite direction will be produced therein.

4. The combination with the branches of a divided circuit carrying alternating currents, of devices including in or connected with the said branches and capable of developing or exerting an active opposition or electro-motive force counter to the current waves of one direction or sign, as herein set forth.

New York December 16<sup>th</sup>  
1889.

Nikola Tesla

Signed in the presence of-

Robert F. Gaylord  
Parker W. Page

Fig. 1

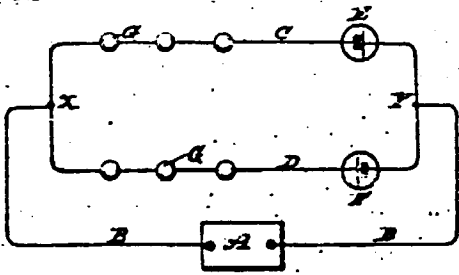

Fig. 2

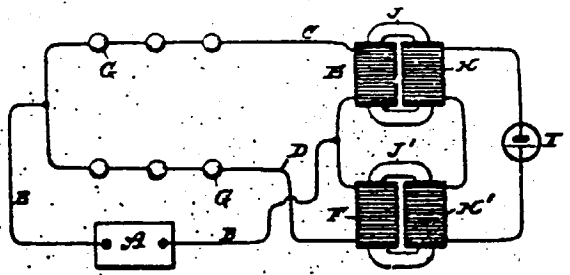

Fig. 3

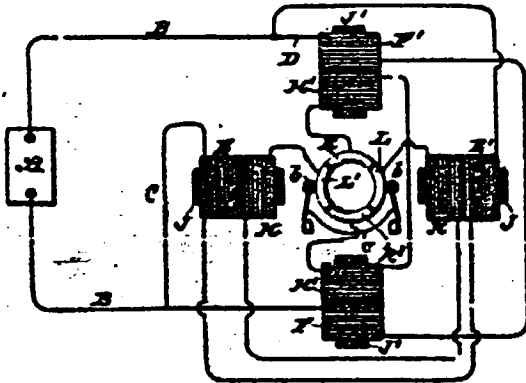

Fig. 4

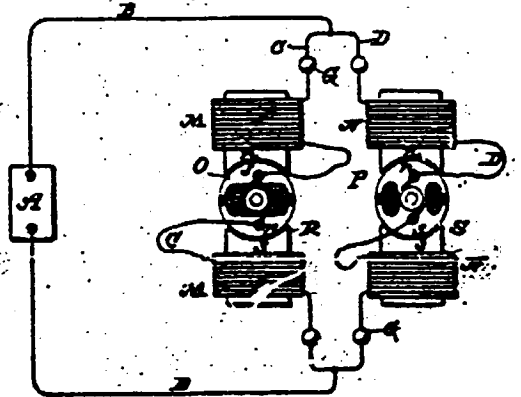

Fig. 5

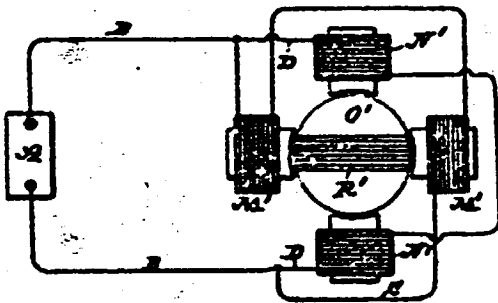

Fig. 6

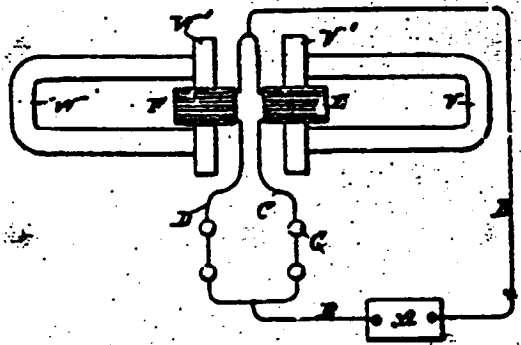
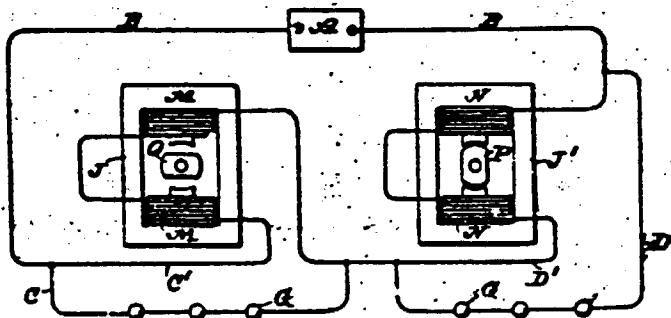

Fig. 7



Witnesses:  
John Crist-  
H. H. Torrey

Certified to be the drawings  
referred to in the specification  
herewith annexed.

Electrician, Int. Dic. 10<sup>th</sup> 1889

Nikola Tesla  
Inventor

By Young, Crist,

Attorneys

23 No. 124063

Department of Agriculture,

PATENT BRANCH,

Ottawa

April 17 1916

Nikola Tesla

PATENT No. 1423522

1423522



MP

COST OF COPIES

PATENT & SPECIFICATION

DRAWING

REVISION

PATH

1916

Handwritten notes at the top of the page: "Handwritten paper... Recd. Feb 11... Aided by car... Feb 12 1916... June 15 1916... June 15 1916... next 6 dupl. sent... Aug 1916... sent by car to... Sept 17/11... Sept 26/11... 3/4 - locked up... 6 July 10/12."

3-8-12

PATENT MAY ISSUE

Handwritten signature of the Chief of Patent Office.

Chief of Patent Office.

Patent dated : 1916

Mailed : 1916

5 20.00 Receipt No. 134948

Acted by car to C. I. H. C.

Nov. Apr 21/06 R. 28

sent 2 - dupl. in tel. Nov. 10/16

Handwritten notes at the bottom right: "Help 7 any to be done... 1916"

To all whom it may concern:

Be it known that I, Nikola Tesla, a citizen of the United States, residing in the Borough of Manhattan, in the City, County, and State of New York, have discovered a new and useful Improvement in the Art of Transmitting Electrical Energy Through the Natural Mediums of which the following is a specification, reference being had to the drawings accompanying and forming a part of the same.

It is known since a long time that electric currents may be propagated through the earth, and this knowledge has been utilized in many ways in the transmission of signals and the operation of a variety of receiving devices remote from the source of energy, mainly with the object of dispensing with a return conducting-wire. It is also known that electrical disturbances may be transmitted through portions of the earth by grounding only one of the poles of the source, and this fact I have made use of in systems which I have devised for the purpose of transmitting through the natural media intelligible signals or power and which are now familiar; but all experiments and observations heretofore made have tended to confirm the opinion held by the majority of scientific men that the earth, owing to its immense extent, although possessing conducting properties, does not behave in the manner of a conductor of limited dimensions with respect to the disturbances produced, but, on the contrary, much like a vast reservoir or ocean, which, while it may be locally disturbed by a commotion of some kind remains unresponsive and quiescent in a large part or as a whole. Still another fact now of common knowledge is that when electrical waves or oscillations are impressed upon such a conducting-path as a metallic wire reflection takes place under certain condi-

tions from the ends of the wire, and in consequence of the interference of the impressed and reflected oscillations the phenomenon of "stationary waves" with maxima and minima in definite fixed positions is produced. In any case the existence of these waves indicates that some of the outgoing waves have reached the boundaries of the conducting-path and have been reflected from the same. Now I have discovered that notwithstanding its vast dimensions and contrary to all observations heretofore made the terrestrial globe may in a large part or as a whole behave toward disturbances impressed upon it in the same manner as a conductor of limited size, this fact being demonstrated by novel phenomena, which I shall hereinafter describe.

In the course of certain investigations which I carried on for the purpose of studying the effects of lightning discharges upon the electrical condition of the earth I observed that sensitive receiving instruments arranged so as to be capable of responding to electrical disturbances created by the discharges at times failed to respond when they should have done so, and upon inquiring into the causes of this unexpected behavior I discovered it to be due to the character of the electrical waves which were produced in the earth by the lightning discharges and which had nodal regions following at definite distances the shifting source of the disturbances. From data obtained in a large number of observations of the maxima and minima of these waves I found their length to vary approximately from twenty-five to seventy kilometers, and these results and certain theoretical deductions led me to the conclusion that waves of this kind may be propagated in all directions over the globe and that they may be of still more widely differing lengths, the extreme limits being imposed by the physical dimensions and

properties of the earth. Recognizing in the existence of these waves an unmistakable evidence that the disturbances created had been conducted from their origin to the most remote portions of the globe and had been thence reflected, I conceived the idea of producing such waves in the earth by artificial means with the object of utilizing them for many useful purposes for which they are or might be found applicable. This problem was rendered extremely difficult owing to the immense dimensions of the planet, and consequently enormous movement of electricity or rate at which electrical energy had to be delivered in order to approximate, even in a remote degree, movements or rates which are manifestly attained in the displays of electrical forces in nature and which seemed at first unrealizable by any human agencies; but by gradual and continuous improvements of a generator of electrical oscillations, which I have described in my United States patents Nos. 645,576 and 649,621, I finally succeeded in reaching electrical movements or rates of delivery of electrical energy not only approximating, but, as shown in many comparative tests and measurements, actually surpassing those of lightning discharges, and by means of this apparatus I have found it possible to <sup>reproduce</sup> ~~reproduce~~ whenever desired phenomena in the earth the same as or similar to those due to such discharges. With the knowledge of the phenomena discovered by me and the means at command for accomplishing these results I am enabled not only to carry out many operations by the use of known instruments, but also to offer a solution for many important problems involving the operation or control of remote devices which for want of this knowledge and the absence of these means have heretofore been entirely impossible. For example, by the use of such a generator of stationary waves and receiving

apparatus properly placed and adjusted in any other locality, however remote, it is practicable to transmit intelligible signals or to control or actuate at will any one or all of such apparatus for many other important and valuable purposes, as for indicating wherever desired the correct time of an observatory or for ascertaining the relative position of a body or distance of the same with reference to a given point or for determining the course of a moving object, such as a vessel at sea, the distance traversed by the same or its speed, or for producing many other useful effects at a distance dependent on the intensity, wave length, direction or velocity of movement, or other feature or property of disturbances of this character.

I shall typically illustrate the manner of applying my discovery by describing one of the specific uses of the same - namely, the transmission of intelligible signals or messages between distant points - and with this object reference is now made to the accompanying drawings, in which -

Figure 1 represents diagrammatically the generator which produces stationary waves in the earth, and Fig. 2 an apparatus situated in a remote locality for recording the effects of these waves.

In Fig. 1, A designates a primary coil forming part of a transformer and consisting generally of a few turns of a stout cable of inappreciable resistance, the ends of which are connected to the terminals of a source of powerful electrical oscillations, diagrammatically represented by G. This source is usually a condenser charged to a high potential and discharged in rapid succession through the primary, as in a type of transformer invented by me and now well known; but when it is desired to produce stationary waves of great lengths an alternating

dynamo of suitable construction may be used to energize the primary A. C is a spirally-wound secondary coil within the primary having the end nearer to the latter connected to the ground E and the other end to an elevated terminal D. The physical constants of coil C, determining its period of vibration, are so chosen and adjusted that the secondary system E C D is in the closest possible resonance with the oscillations impressed upon it by the primary A. It is, moreover, of the greatest importance in order to still further enhance the rise of pressure and to increase the electrical movement in the secondary system that its resistance be as small as practicable and its self-induction as large as possible under the conditions imposed. The ground should be made with great care, with the object of reducing its resistance. Instead of being directly grounded, as indicated, the coil C may be joined in series or otherwise to the primary A, in which case the latter will be connected to the plate E; but be it that none or a part or all of the primary or exciting turns are included in the coil C the total length of the conductor from the ground-plate E to the elevated terminal D should be equal to one-quarter of the wave length of the electrical disturbance in the system E C D or else equal to that length multiplied by an odd number. This relation being observed, the terminal D will be made to coincide with the points of maximum pressure in the secondary or excited circuit, and the greatest flow of electricity will take place in the same. In order to magnify the electrical movement in the secondary as much as possible, it is essential that its inductive connection with the primary A should not be very intimate, as in ordinary transformers, but loose, so as to permit free oscillation - that is to say, their mutual induction should



be small. The spiral form <sup>of coil</sup> <sub>A</sub> C secures this advantage, while the turns near the primary A are subjected to a strong inductive action and develop a high initial electromotive force. These adjustments and relations being carefully completed and other constructive features indicated rigorously observed, the electrical movement produced in the secondary system by the inductive action of the primary A will be enormously magnified, the increase being directly proportionate to the inductance and frequency and inversely to the resistance of the secondary system. I have found it practicable to produce in this manner an electrical movement thousands of times greater than the initial - that is, the one impressed upon the secondary by the primary A - and I have thus reached activities or rates of flow of electrical energy in the system E C D measured by many tens of thousands of horsepower. Such immense movements of electricity give rise to a variety of novel and striking phenomena, among which are those already described. The powerful electrical oscillations in the <sup>System</sup> ~~system~~ E C D being communicated to the ground cause corresponding vibrations to be propagated to distant parts of the globe, whence they are reflected and by interference with the outgoing vibrations produce stationary waves the crests and hollows of which lie in parallel circles relatively to which the ground-plate E may be considered to be the pole. Stated otherwise, the terrestrial conductor is thrown into resonance with the oscillations impressed upon it just like a wire. More than this, a number of facts ascertained by me clearly show that the movement of electricity through it follows certain laws with nearly mathematical rigor. For the present it will be sufficient to state that the planet behaves like a perfectly smooth or polished conductor of inappreciable resistance with

capacity and self induction uniformly distributed along the axis of symmetry of wave propagation and transmitting slow electrical oscillations without sensible distortion and attenuation.

Besides the above three requirements seem to be essential to the establishment of the resonating condition.

First. The earth's diameter passing through the pole should be an odd multiple of the quarter wave length - that is, of the ratio between the velocity of light - and four times the frequency of the currents.

Second. It is necessary to employ oscillations in which the rate of radiation of energy into space in the form of hertzian or electromagnetic waves is very small. To give an idea, I would say that the frequency should be smaller than twenty thousand per second, though shorter waves might be practicable. The lowest frequency would appear to be six per second, in which case there will be but one node, at or near the ground-plate, and, paradoxical as it may seem, the effect will increase with the distance and will be greatest in a region diametrically opposite the transmitter. With oscillations still slower the earth, strictly speaking, will not resonate, but simply act as a capacity, and the variation of potential will be more or less uniform over its entire surface.

Third. The most essential requirement is, however, that irrespective of frequency the wave or wave-train should continue for a certain interval of time, which I have estimated to be not less than one-twelfth or probably 0.08484 of a second and which is taken in passing to and returning from the region diametrically opposite the pole over the earth's surface with a mean velocity of about four hundred and seventy-one thousand two hundred and forty kilometers per second.

The presence of the stationary waves may be detected in many ways. For instance, a circuit may be connected directly or inductively to the ground and to an elevated terminal and tuned to respond more effectively to the oscillations. Another way is to connect a tuned circuit to the ground at two points lying more or less in a meridian passing through the pole E or, generally stated, to any two points of a different potential.

In Fig. 2 I have shown a device for detecting the presence of the waves such as I have used in a novel method of magnifying feeble effects which I have described in my United States patents Nos. 695,953 and 635,955. It consists of a cylinder of insulating material, which is moved at a uniform rate of speed by clockwork or other suitable motive power and is provided with two metal rings B B, upon which bear brushes a and a', connected, respectively, to the terminal plates P and P'. From the rings B B extend narrow metallic segments s and s', which by the rotation of the cylinder are brought alternately into contact with double brushes b and b', carried by and in contact with conducting-holders h and h', supported in metallic bearings D' D', as shown. The latter are connected to the terminals T and T' of a condenser C', and it should be understood that they are capable of angular displacement as ordinary brush-supports. The object of using two brushes, as b and b', in each of the holders h and h' is to vary at will the duration of the electric contact of the plates P and P' with the terminals T and T', to which is connected a receiving-circuit including a receiver R and a device d, performing the duty of closing the receiving-circuit at predetermined intervals of time and discharging the stored energy through the receiver. In the present case this device consists of a cylinder made partly of conducting and partly of

insulating material e and e', respectively, which is rotated at the desired rate of speed by any suitable means. The conducting part e is in good electrical connection with the shaft S and is provided with tapering segments f f, upon which slides a brush k, supported on a conducting-rod l, capable of longitudinal adjustment in a metallic support m. Another brush, n, is arranged to bear upon the shaft S, and it will be seen that whenever one of the segments f comes in contact with the brush k the circuit including the receiver R is completed and the condenser discharged through the same. By an adjustment of the speed or rotation of the cylinder d and a displacement of the brush k along the cylinder the circuit may be made to open and close in as rapid succession and remain open or closed during such intervals of time as may be desired. The plates P and P', through which the electrical energy is conveyed to the brushes a and a', may be at a considerable distance from each other in the ground or one in the ground and the other in the air, preferably at some height. If but one plate is connected to earth and the other maintained at an elevation, the location of the apparatus must be determined with reference to the position of the stationary waves established by the generator, the effect evidently being greatest in a maximum and zero in a nodal region. On the other hand, if both plates be connected to earth the points of connection must be selected with reference to the difference of potential which it is desired to secure, the strongest effect being of course obtained when the plates are at a distance equal to half the wave length.

In illustration of the operation of the system let it be assumed that alternating electrical impulses from the generator are caused to produce stationary waves in the earth, as above

described, and that the receiving apparatus is properly located with reference to the position of the nodal and ventral regions of the waves. The speed of rotation of the cylinder first described is varied until it is made to turn in synchronism with the alternate impulses of the generator, and the position of the brushes b and b' is adjusted by angular displacement or otherwise, so that they are in contact with the segments s and s' during the periods when the impulses are at or near the maximum of their intensity. These requirements being fulfilled, electrical charges of the same sign will be conveyed to each of the terminals of the condenser, and with each fresh impulse it will be charged to a higher potential. The speed of rotation of the cylinder d being adjustable at will, the energy of any number of separate impulses may thus be accumulated in potential form and discharged through the receiver R upon the brush k coming in contact with one of the segments f. It will be understood that the capacity of the condenser should be such as to allow the storing of a much greater amount of energy than is required for the ordinary operation of the receiver. Since by this method a relatively great amount of energy and in a suitable form may be made available for the operation of a receiver, the latter need not be very sensitive; but when the impulses are very weak or when it is desired to operate a receiver very rapidly any of the well-known sensitive devices capable of responding to very feeble influences may be used in the manner indicated or in other ways. Under the conditions described it is evident that during the continuance of the stationary waves the receiver will be acted upon by current impulses more or less intense, according to its location with reference to the maxima and minima of said waves; but upon interrupting or reducing

the flow of the current the stationary waves will disappear or diminish in intensity. Hence a great variety of effects may be produced in a receiver, according to the mode in which the waves are controlled. It is practicable, however, to shift the nodal and ventral regions of the waves at will from the sending-station, as by varying the length of the waves under observance of the above requirements. In this manner the regions of maximum and minimum effect may be made to coincide with any receiving station or stations. By impressing upon the earth two or more oscillations of different wave length a resultant stationary wave may be made to travel slowly over the globe, and thus a great variety of useful effects may be produced. Evidently the course of a vessel may be easily determined without the use of a compass, as by a circuit connected to the earth at two points, for the effect exerted upon the circuit will be greatest when the plates P P' are lying on a meridian passing through ground-plate E and will be nil when the plates are located at a parallel circle. If the nodal and ventral regions are maintained in fixed positions, the speed of a vessel carrying a receiving apparatus may be exactly computed from observations of the maxima and minima regions successively traversed. This will be understood when it is stated that the projections of all the nodes and loops on the earth's diameter passing through the pole or axis of symmetry of the wave-movement, are all equal. Hence, in any region at the surface the wave-length can be ascertained from simple rules of geometry. Conversely, knowing the wave-length, the distance from the source can be readily calculated. In like ways the distance of one point from another, the latitude and longitude, the hour, etc., may be determined from the observation of such stationary waves. If several such genera-

tors of stationary waves - preferably of different lengths - were installed in judiciously selected localities, the entire globe could be sub-divided in definite zones of electric activity and such and other important data could be at once obtained by simple calculation or readings from suitably graduated instruments.

The specific plan of producing the stationary waves, herein described, might be departed from. For example, the circuit which impresses the powerful oscillations upon the earth might be connected to the latter at two points.

In collecting the energy of these disturbances in any terrestrial region at a distance from their source, for any purpose and, more especially, in appreciable amounts, the most economical results will be generally secured by the employment of my synchronized receiving transformer. This invention, forming part of my system of transmission of energy through the natural media, has been fully explained in the patents first cited here, but for the better understanding of the present description it is diagrammatically illustrated in Fig. 3. Its most essential part is a circuit  $E_1 C_1 D_1$  which is connected, arranged and adjusted similarly to the transmitting circuit  $E C D$  and which is inductively linked with a secondary circuit  $A_1$ . The latter, it scarcely need be stated, may be wound with any desired number of turns, such as will be best suited for the operation of the device designated by M. The receiving transformer is closely attuned to the oscillations of the transmitting circuit so that, irrespective of the length of the conductor  $E_1 C_1 D_1$  the points of maximum potential coincide with the elevated terminal  $D_1$  under which conditions the greatest amount of wave energy may be collected and rendered available in the secondary circuit  $A_1$

for useful purposes.

To complete this description, it may be stated that when it is desired to operate, independently, a great many receiving devices, by such stationary waves of different lengths, the principles which I have set forth in my British patent 14,579 (1901) and in my United States patents Nos. 723,188 and 725,605 (1903) may be resorted to for rendering the signals or quantities of energy intended for any <sup>particular</sup> receiver or receivers non-interfering and non-interferable.

In the above I have briefly outlined my discovery and indicated only a few uses of the same, but it will be readily seen, that it is of transcending importance for the advancement of many arts and industries, new and old, and capable of innumerable valuable applications.



What I claim as my invention is:

1. The art herein described for transmitting electrical energy to a distance consisting in establishing stationary electrical waves in the earth by impressing thereon electrical oscillations of definite frequency.
2. The art herein described for transmitting electrical energy to a distance consisting in establishing electrical oscillations and impressing said oscillations upon the earth and producing therein stationary electric waves.
3. The art herein described for transmitting and utilizing electrical energy consisting in establishing stationary electrical waves in the earth, and operating thereby one or more receiving devices remote from the source of energy.
4. The art herein described for transmitting and utilizing electrical energy consisting in establishing stationary electrical waves in the earth, and operating thereby one or more receiving devices remote from the source of energy and properly located with respect to the position of said waves.
5. The art herein described for transmitting and utilizing electrical energy consisting in establishing stationary electrical waves in the earth, and varying the length of such waves.
6. The art herein described for transmitting and utilizing electrical energy consisting in establishing stationary electrical waves in the earth, and shifting the nodal and ventral regions of said waves.
7. The art herein described for transmitting electrical energy consisting in producing stationary electrical oscillations of definite lengths, impressing said oscillations upon the natural conducting medium and causing thereby a resultant wave or effect to travel slowly over said medium.

8. The art herein described for transmitting electrical energy which consists in establishing stationary electrical waves of different lengths varying the lengths of said waves and causing thereby a resultant wave or affect to travel with the desired velocity throughout the natural medium.

9. The art herein described for transmitting and utilizing electrical energy consisting in establishing stationary electrical waves, impressing said waves upon the natural conducting medium, varying the intensity of said waves and producing thereby perceptible affects in distant receivers.

10. The art of producing affects at a distance consisting in establishing stationary electrical waves, impressing said waves upon the terrestrial globe, varying the characteristics and relations of said waves and causing thereby affects in distant receivers.

11. The art herein described for transmitting and utilizing electrical energy consisting in establishing stationary electrical waves, impressing the affect of said waves upon the natural medium, positioning receiving apparatus at different places through said medium and determining from the affects or indications of said receiving apparatus the condition of said medium.

12. The art herein described for transmitting electrical energy consisting in establishing electrical waves of definite length and duration and impressing said waves upon the natural medium and thereby throwing said natural medium into resonance.

13. The art herein described for creating great electrical movements in the natural medium, which consists in establishing electrical waves of definite length and duration and impressing said waves upon said natural medium until the same becomes resonant.

14. In a system for the transmission of electrical energy, transmitting apparatus comprising a primary exciting circuit energized by a generator of alternating currents and a resonant secondary circuit of high self-induction and small resistance loosely linked with the primary and adapted for throwing the terrestrial globe into resonance, as set forth.

15. In the system for the transmission of electrical energy, a source of primary electrical oscillations such as a condenser circuit and a secondary circuit inductively linked with the same and adapted for throwing the terrestrial globe into resonance, as specified.

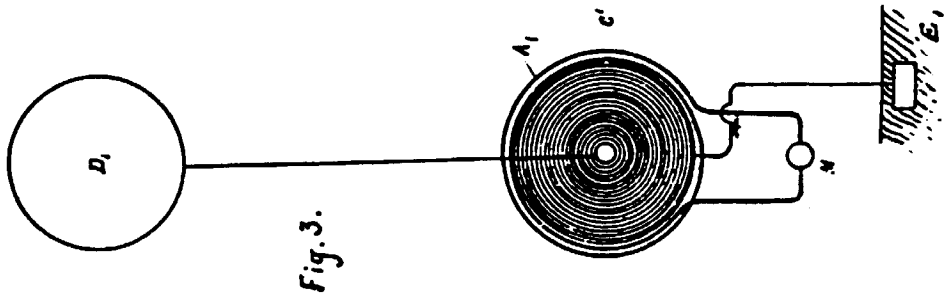

Fig. 3.

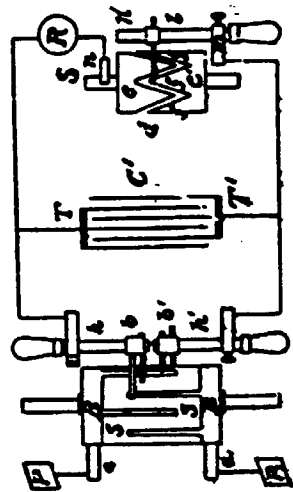

Fig. 2.



Fig. 1.

Witnesses:

*Thomas A. Quinn*  
*Henry J. [unclear]*

Consisted to the drawings, referred to  
in the Specification herewith annexed.  
Ottawa, Feb. 12, 1909.

Inventor:

*W. S. [unclear]*